

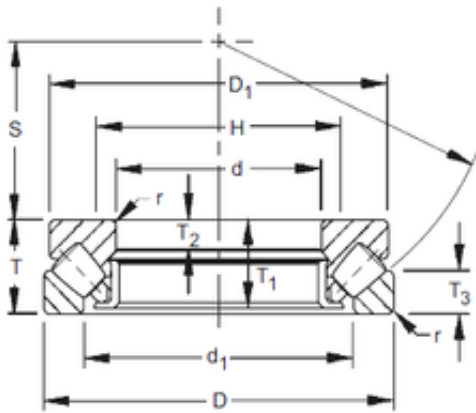

Huaxin Bearing Co., Ltd



29488 Bearing 2D drawings and 3D CAD models

29488 TIMKEN Tapered Roller bearings double-row

Bearing No. 29488

Size	440x780x206 mm
Bore Diameter	440 mm
Outer Diameter	780 mm
Width	206 mm
d	440 mm
D	780 mm
T	206 mm
B	74 mm
C	99 mm
r max	7,1 mm
T1	199 mm
d1	588 mm
D1	745 mm
H	595 mm
S	257 mm