

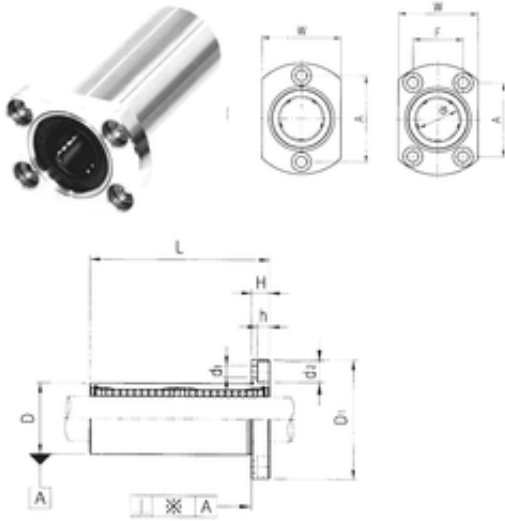

# Huaxin Bearing Co., Ltd



LMH8LUU Bearing 2D drawings and 3D CAD models

## Samick LMH8LUU linear bearings

Bearing No. LMH8LUU

Bore Diameter	8 mm
Outer Diameter	15 mm
d	8 mm
D	15 mm
d1	3,4 mm
d2	6,5 mm
h	3,3 mm
A	24 mm
D1	32 mm
H	5 mm
L	45 mm
W	21 mm
Tolerance perpendicularity (C)	15
Weight	0,053 Kg
Basic dynamic load rating (C)	0,43 kN